

Automation Devices, Inc.

MODEL 5100 IN-LINE FEEDER INSTRUCTIONS

➤ DESCRIPTION

The Model 5100 Series of In-Line Feeders convey oriented parts in a linear motion across tracks designed to transport a specific part. ADI's unique self-cancelling design reduces the amount of vibration transmitted to the mounting surface. This type of feeding device can be fastened directly to a machine base and requires no rubber feet for mounting. **Reliable track alignment is obtained through the absence of rubber feet.**

The theory behind the operation of the In-Line Feeder is that all the forces generated by the action mass (top plate and track) are cancelled by the forces generated by the reaction mass (inner system of springs and weights). In order to have all the forces cancel, the center of gravity of both the action and the reaction masses should be at the same point.

The Model 5100 In-Line is designed so that it is possible to add the weight of a track to the top or action mass and this will, in most cases, bring the centers of gravity very close together. The track should have its center of gravity as close to the midpoint of the top of the In-Line Feeder as possible for optimum results.

➤ LOAD RATING

The Load Rating is the total weight of all components including hardware that will be placed on the top of the In-Line (i.e. the track, shim stock, screws, washers, etc.). **Note: The weight of the parts you are feeding do not add to the Load Rating.**

The figure you give should not be off more than 5%. A unit tuned for a 16 ounce load rating will exhibit very little part movement when trying to vibrate a 16.8 ounce track. If the track weighs only 15 ounces, add weight to move it closer to the 16 ounce rating.

➤ OPERATION

The Model 5100 In-Line Feeder will operate on 60 Hz standard line current; **however, units may be ordered for 50 Hz operation.** Units are manufactured for 24 VAC, 120 VAC, and for 240 VAC power sources and must be specified when ordered. The In-Line will operate continuously at the full rated voltage; however, ADI manufactures a Model 6000 Series controller which, *when set for AC operation* (7200 Vibrations per Minute), will provide an adjustable full-wave AC output to control the vibration amplitude of the Model 5100 In-Line Feeder.

Please consult the factory to discuss any difficult parts feeding problems (oily or glass parts) or any other abnormal parts feeding conditions (track weight or length).



Model 5100
In-Line Feeder

➤ IN-LINE MOUNTING & INSTALLATION

Never mount an In-Line Feeder on an overhanging plate. Heavy tracks swinging .050 inches in each direction need a solid mounting base. Typical In-Line applications require that they be elevated to bring the track up to the level of the discharge of the vibratory parts feeder. See below.

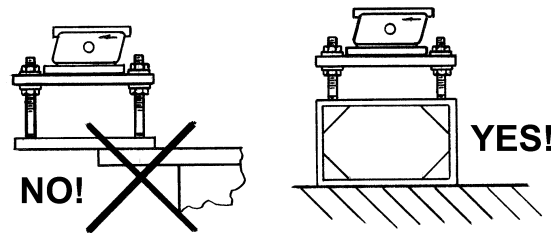

In-Lines are tuned *without* rubber feet unless specified at the time of ordering. However, some applications may require rubber feet. If any form of rubber mount will be used, the In-Line may have to be returned.

➤ TROUBLESHOOTING AFTER INSTALLATION

Find out what differences exist from how the In-Line Feeder was tested at ADI versus the way the In-Line is set up at your facility.

- Does the unit make any noise ... a slight hum? Check your power source up to the connection to the In-Line's coil.
- Are you using the correct controller? Is it set to AC?
- Does the weight of your track and mounting hardware match the load rating stamped on the In-Line's side plate?
- Are the track mounting screws *too long* and restricting the movement of the reaction mass inside the In-Line?
- Is there enough clearance between the In-Line track and the parts feeder's discharge? What about between the track and the device receiving the In-Line's parts?

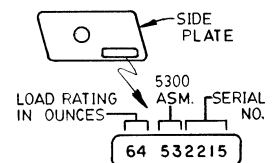

➤ REPAIR PARTS

Replacement parts are listed in the exploded view shown in Document AF01.01. When placing a parts order, please provide the operating voltage and the serial number of each In-Line Feeder.

➤ **TRACK DESIGN**

The maximum length of the track should not exceed 12 inches. The track should be centered over the In-Line with no more than three inches of overhang at either end.

If you use 1/8 inch thick material on gravity tracks, you may want to use 3/16 inch thick material for the sides of the In-Line tracks. **Note:** Any material that lies directly on top of the In-Line (shims, risers, etc.) can be of thinner stock. If you need a thicker riser, use light-weight material.

Covers may be required to assist in maintaining the orientation of parts that are being conveyed via In-Line Feeders. Care should be taken not to restrict part movement. Remember that the track is, in fact, moving up and down under vibration. The clearance

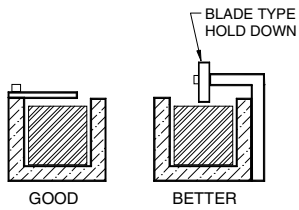

between the underside of the cover and the top of a part is critical with regard to the forward movement of the part under vibration. It is also

worthy of note to minimize the area that the covers occupy in the event that a bent part would need to be removed from the track. Where practical, designs using a round rod or thin blade are less restrictive to the forward motion of parts while still assisting with maintaining part orientation.

➤ **MOUNTING THE TRACK**

Eight #10-32 mounting holes in the top mounting plate fasten the track. The track should be sufficiently rigid so that any overhanging portion does not flex and defeat the feeding action of the In-Line Feeder. The track should have its center of gravity as close to the midpoint of the top of the In-Line Feeder as possible for optimum results. **Avoid excessive track overhang.** No more than 1/4 of the track should overhang either end of the In-Line's top casting.

Long Tracks – This drawing illustrates the preferred location of two In-Lines, in series or tandem, that power a long track. **We recommend to split the track wherever possible.**

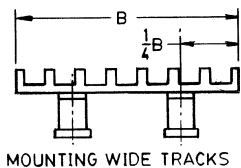
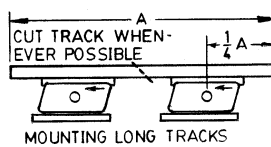

Wide Tracks – Two In-Lines in parallel, or side-by-side, are the solution when the track is short but very wide.

Auxiliary Spring Assemblies are another option when dealing with long tracks.

This springing method uses only one In-Line Feeder.

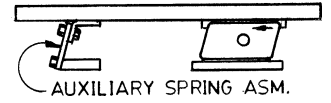

➤ **SOLENOID TO ARMATURE GAP ADJUSTMENT**

After a feeder's springing has been adjusted, a higher amplitude of vibration may cause the laminations of the feeder's solenoid (Part Number 5111) to begin hammering, or striking, on the armature plate (Part Number 5116). When this occurs, you can hear the noise emitted from the In-Line. *Another common cause of this hammering is a line voltage increase at your plant.*

Determine the present gap before making the adjustment. Loosen the side plates after measuring the gap. Insert a shim .005 inches greater than the measured gap when adjusting the Model 5100. Slide the side plates so that the shim is held firmly between the coil and armature. **Make sure the working surfaces of the coil and the armature are parallel to each other.** Tighten the screws that hold the side plates and remove the shim.

The Model 5100 should have a coil gap in the range of .025 to .050 inches.

If you have a relatively constant line voltage supply, then increasing the size of the solenoid/armature gap will decrease the feeder's amplitude. Conversely, decreasing the size of the gap will increase the feeder's amplitude.

➤ **MODEL 5100 DIMENSIONS**

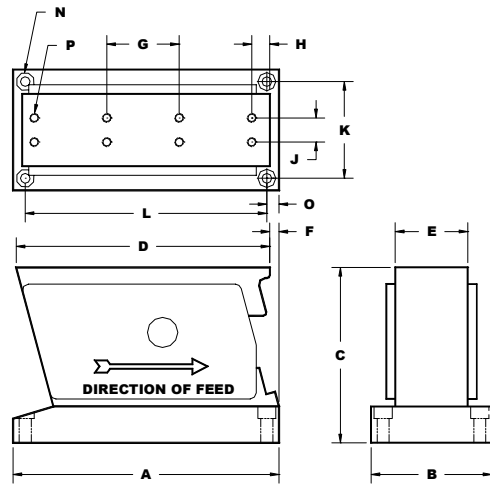

A	B	C	D	E	F	G	H
5 1/2	2 1/2	3 5/8	5 1/4	1 1/2	3/16	1 1/2	3/8

J	K	L	N Holes	O	P Holes	Shipping Weight
1/2	2	5	1/4 - 20 (4 holes)	1/4	#10-32 (8 holes)	5 pounds

IF01.01

Automation Devices, Inc.

7050 West Ridge Road
Fairview, PA 16415-2099

Phone: 814-474-5561

FAX: 814-474-2131 or 800-235-9382

Web Site: www.autodev.com E-mail: info@autodev.com