



**Amplitude Controller  
Model 6000 Series  
OPEN FRAME**



**MODEL 6006.1**

**FLUSH MOUNT**



**Input: 120 VAC  
50/60 HZ.**

**Output: 0-120 VAC  
Single Unit Fuse Size: 15 AMPS  
80% Duty Cycle at Rated AMPS**

**Note: Mount Open Frame controls within an enclosure.**

## ADJUSTMENTS AND SET UP

### 1. SELECTING OUTPUT PULSE MODE

Choose an output mode of 120 or 60 by sliding the OUTPUT PULSE switch to the appropriate position.

Other names for "120 Pulses Per Second" are AC or 7200 VPM (Vibrations Per Minute). "60" is the same as DC or 3600 VPM or Rectified.

**Note: Readjust MAX pot after changing pulse mode setting.**

### 2. LIMITING THE MAXIMUM OUTPUT OF CONTROL

Adjust the **MAX** Output trimpot so that the output to the feeder reaches its desired maximum level when the **MAIN CONTROL DIAL** is turned fully clockwise. The **MAX** Output trimpot should be adjusted to keep the vibratory feeder from hammering when the control is turned up to full power.

**NOTE: Output to feeder must be connected and the control set for proper output frequency (60 or 120 pulse) setting. The Run Jumper must be connected as shown on the wiring diagram.**

- A. Power input should be **OFF** or disconnected.
- B. Rotate **MAIN CONTROL DIAL** on front cover to 0 or its minimum setting.
- C. Open cover to allow access to printed circuit card.
- D. Using **CAUTION**, turn power **ON** (no output should be present).
- E. Rotate the **MAIN CONTROL DIAL** on front cover slowly to its highest setting.
- F. Adjust the **MAX** output trimpot so that the output to the feeder reaches its desired maximum level when the **MAIN CONTROL DIAL** is turned fully clockwise. Turning the

**MAX** output trimpot clockwise increases the maximum output level.

### 3. SETTING THE MINIMUM OUTPUT LEVEL OF CONTROL

When the vibratory feeder is nearly empty, turn the **MAIN CONTROL DIAL** fully counter-clockwise and adjust the **MIN** trimpot to just below the slowest speed that provides the proper feed rate.

### 4. REMOTE OFF/ON CONTROL

A Run Jumper has been installed at the factory as shown on the enclosed wiring diagram.

Note: TB2 terminals 5-7 are referenced to the line voltage circuit. Therefore any switch or contact connected to them must be isolated from other circuits.

Remote OFF/ON operation of the control can be configured to operate in one of the following ways.

- A. A low current switch such as a paddle switch can replace the factory-installed Run Jumper "J1." The "Run Contact" connects across terminals 6 and 7. The contact must be able to switch 5VDC and 2mA. The control will then run only when the contact is closed. Refer to Section A of the OFF/ON CONTROL GUIDE.
- B. Feeder Bowl/Hopper Interlock allows the Hopper control to operate only when the Bowl is running and the paddle switch contact is closed. The **interlock input** on terminals 11 and 12 of TB2 is controlled by the **Sensi-tron Controller**.

Remove jumper "J1" of this control from terminals 6 and 7. Connect the Hopper Paddle switch to alternate terminals 5 and 6. Connect TB2 terminals 11 and 12 of this control to the Switched 12V output of the **Sensi-tron Controller**. Refer to Section B of the OFF/ON CONTROL GUIDE.

Note: Two 6000 Series controls will not interlock to each other since neither one has an **interlock output**.

C. **Low Voltage DC** can be used to turn the control **ON** and **OFF**. Move jumper "J1" from terminal 7, to terminal 5, (6 remains the same). Then connect the positive signal (+5 to 30VDC @ 10mA) to terminal 12 and the negative to terminal 11 of TB2. The control will now turn **ON** when the DC signal is present at terminals 11 and 12 of TB2. This input is optically isolated. Refer to Section C of the OFF/ON CONTROL GUIDE.

D. **AC Voltage** may be used to turn the control **ON** and **OFF**. This requires a 105-250VAC signal, with 2mA maximum off-state leakage. Set up the control by moving the jumper "J1" from terminal 7, to terminal 5, (6 remains the same). Connect the 105-250VAC Signal to terminal 12 (L1) and the common (L2) to terminal 10 of TB2. The 6000 Series control will now turn **ON** whenever the AC signal is applied to terminals 10 and 12 of TB2. This input is optically isolated. Refer to Section D of the OFF/ON CONTROL GUIDE.

## 5. MAIN CONTROL DIAL

The output power is controlled by the **MAIN CONTROL DIAL**. A special logarithmic-tapered power-out curve (non-linear) spreads the power broadly across the **MAIN CONTROL DIAL** to help give maximum "Fine Control" over the output speed of the vibratory feeder. When very precise adjustment of the **MAIN CONTROL DIAL** is needed, increase the MIN trimpot setting and/or decrease the MAX trimpot setting. Use of an external analog signal in place of the control potentiometer is not recommended.

## 6. SETTING THE SOFT-START

The start-up of the control output can be adjusted to ramp up to the desired output level instead of starting abruptly. This keeps parts from falling off the tooling of a vibratory feeder when it turns on; it can reduce hammering during turn on; it can also simulate a paddle switch ON delay. Adjust the **SOFT Start** trimpot clockwise for the gentlest start (about a 10-second ramp up to full output). Turn the trimpot fully counter-clockwise for no soft start.

## 7. ADVANCED FEATURE PROGRAMS

Advanced features are available for specialized applications. These features can be enabled by the end user: 60 pulse waveform reversal; Main Control Dial follows a fixed curve; Control output turns off when the Main Control Dial is at 0; MIN pot disable, Power conservation mode; High speed/low speed/off operation; and Low pulse rates of 30, 20, 15, 10. For a full description of these features, please consult the factory.

### WARNING:

**Fuses should be replaced with Littelfuse 3AB "Fast Acting" type or equivalent of manufacturer's original value.**

**Mounting this control directly to a vibrating device will void the warranty.**

### TROUBLESHOOTING

Basic Procedure – To ascertain whether the problem lies in the controller, take the following steps:

- Check that the fuse is good. Disconnect the input power and tighten the screw terminals.
- Make sure that the proper input power is present and the RUN jumper is connected. The output should turn on anytime the **MAIN CONTROL DIAL** is turned up and a wire is connected from TB2-6 to TB2-7.
- Connect an AC voltmeter across the LOAD terminals (with the LOAD connected) and vary the **MAIN CONTROL DIAL** from minimum to maximum. In 120 pulse mode, the output should vary from approximately 30% to 98% of the input voltage depending on the setting of the **MIN** and **MAX** trimpots. In 60 pulse mode the output should vary from 20% to around 85% of the input voltage.
- On new installations: If the Feeder only hums but it doesn't feed any parts, try changing the **60/120** switch to the opposite position.

When neither a humming sound nor any vibration can be detected in the vibratory feeder, the problem may be in the controller.

NOTE: The enclosure may feel quite warm when the load current is in the 12-15 Amp range.

## DIMENSIONS

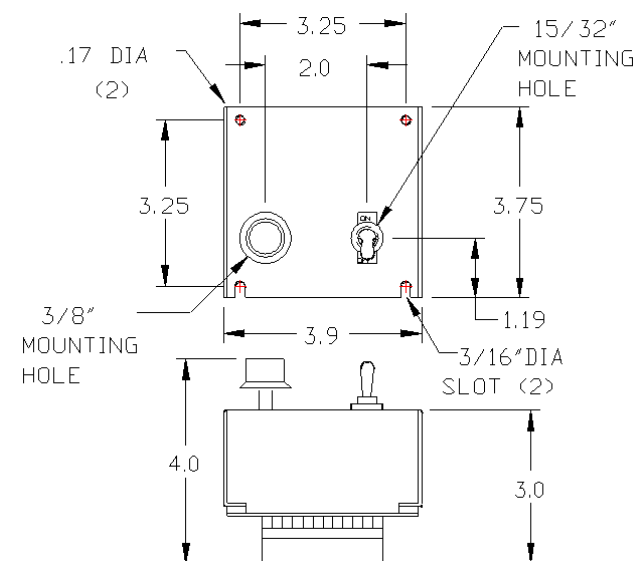

### In USA: Automation Devices, Inc.

7050 West Ridge Road  
Fairview, PA 16415-2099  
Phone: 814-474-5561  
FAX: 814-474-2131 or 800-235-9382  
Web Site: [WWW.AUTODEV.COM](http://WWW.AUTODEV.COM)  
E-mail: [SALES@AUTODEV.COM](mailto:SALES@AUTODEV.COM)

### In Canada: Automation Devices, LTD.

4700 Montrose Road  
Niagara Falls, Ontario L2H 1K3  
Phone: 905-354-3881  
FAX: 905-354-4072  
Web Site: [WWW.ADLCAN.COM](http://WWW.ADLCAN.COM)  
E-mail: [SALES@ADLCAN.COM](mailto:SALES@ADLCAN.COM)

• **TYPICAL SYSTEM WIRING DIAGRAM** •

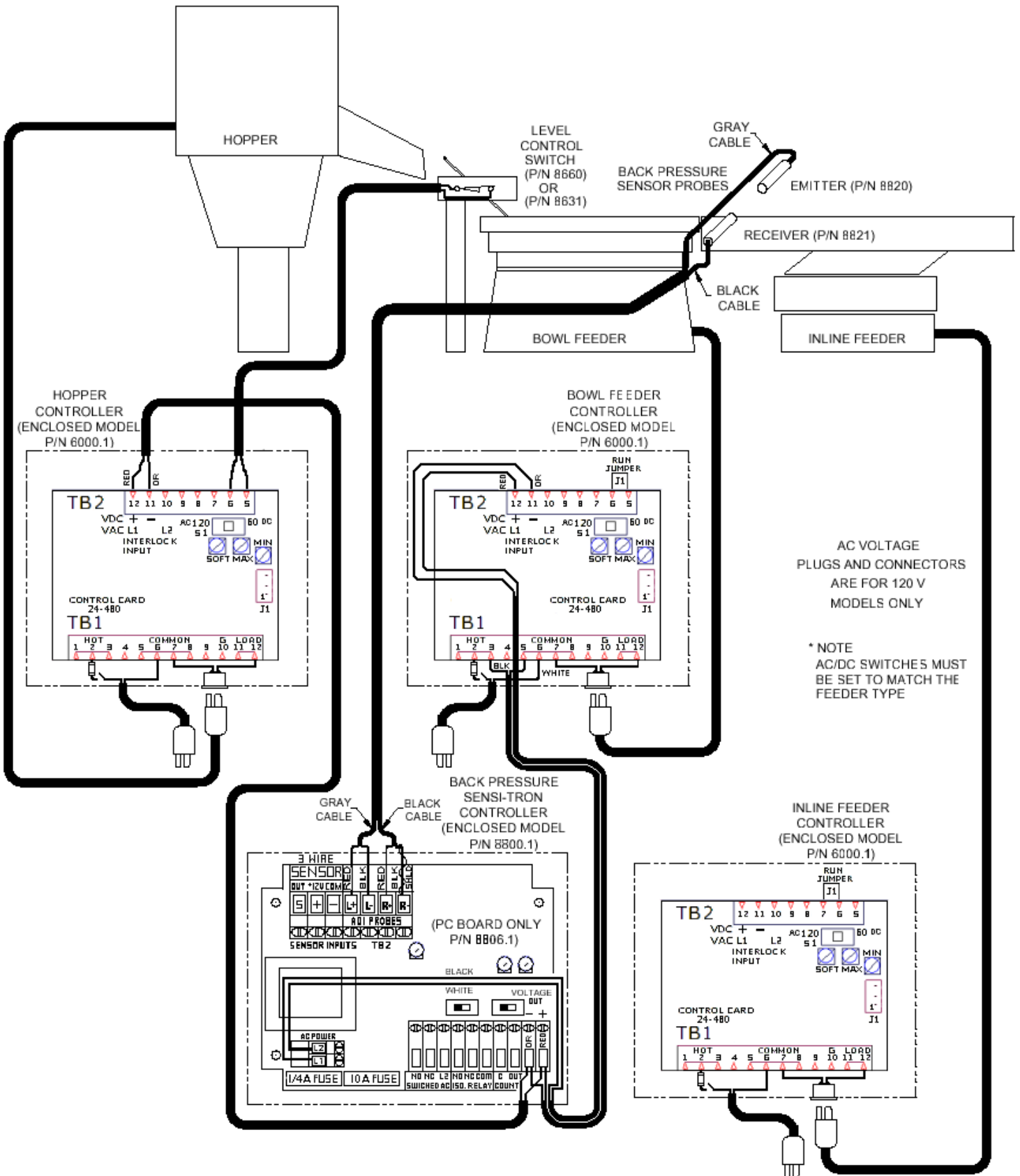

# Automation Devices, Inc.

## In USA: Automation Devices, Inc.

7050 West Ridge Road  
 Fairview, PA 16415-2099  
 Phone: 814-474-5561  
 FAX: 814-474-2131 or 800-235-9382  
 Web Site: [WWW.AUTODEV.COM](http://WWW.AUTODEV.COM)  
 E-mail: [SALES@AUTODEV.COM](mailto:SALES@AUTODEV.COM)

## In Canada: Automation Devices, LTD.

4700 Montrose Road  
 Niagara Falls, Ontario L2H 1K3  
 Phone: 905-354-3881  
 FAX: 905-354-4072  
 Web Site: [WWW.ADLCAN.COM](http://WWW.ADLCAN.COM)  
 E-mail: [SALES@ADLCAN.COM](mailto:SALES@ADLCAN.COM)

### MODEL 6006.1 OPEN FRAME MODEL IMPORTANT: APPLICATION NOTE

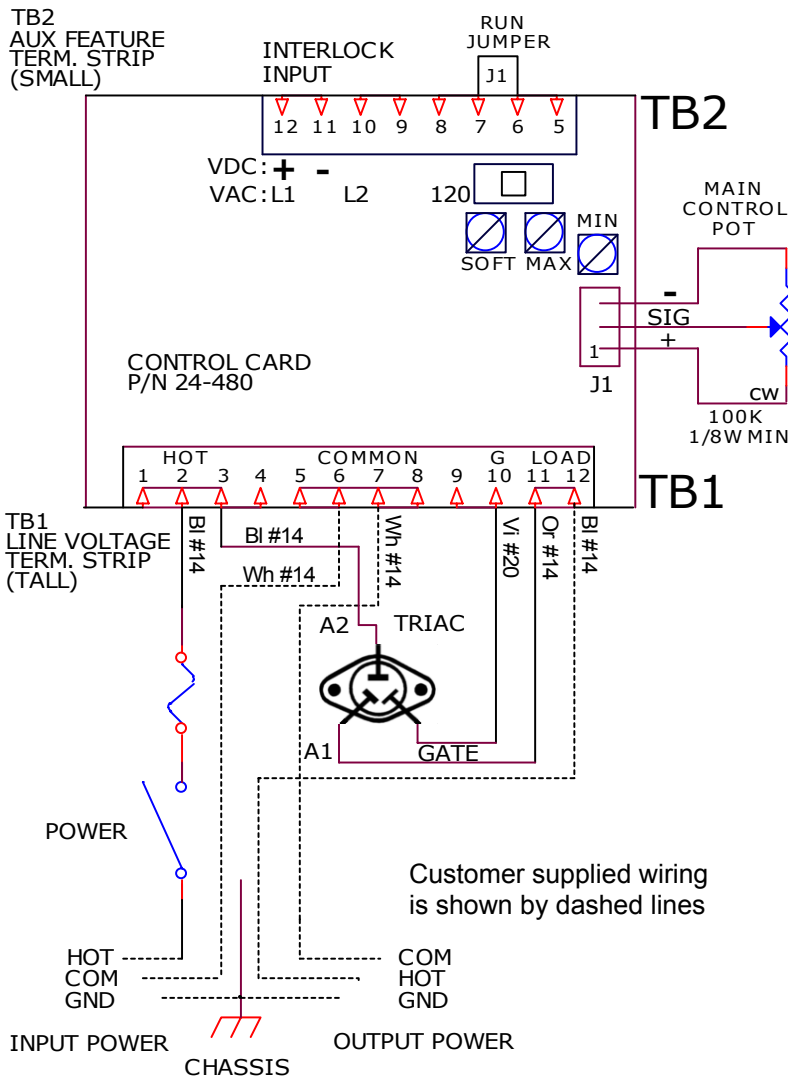

## OFF/ON CONTROL GUIDE

See section 4 of the Application Note for more details.

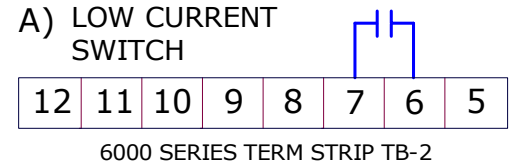

## B) FEEDER BOWL/HOPPER INTERLOCK

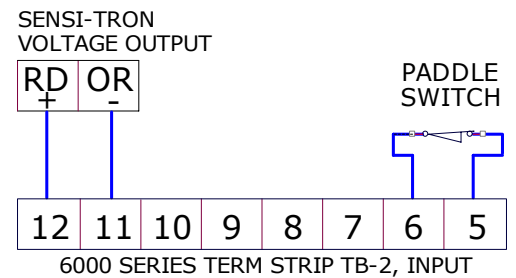

## C) LOW VOLTAGE INPUT SWITCHING (DC Voltage from PLC)

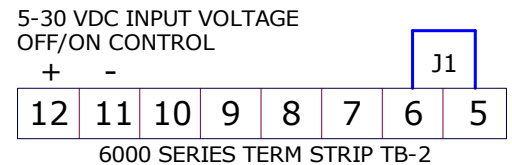

## D) AC VOLTAGE INPUT SWITCHING

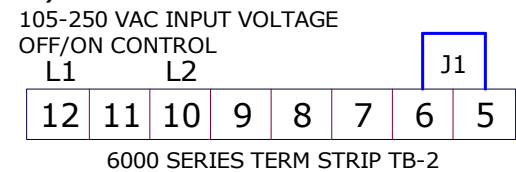

## TRIAC REFERENCE GUIDE

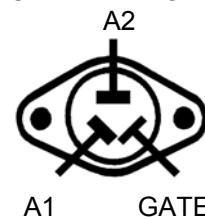

MODEL	INPUT VAC	AMPS	OUTPUT
6006.1	120VAC	15A	0-120